

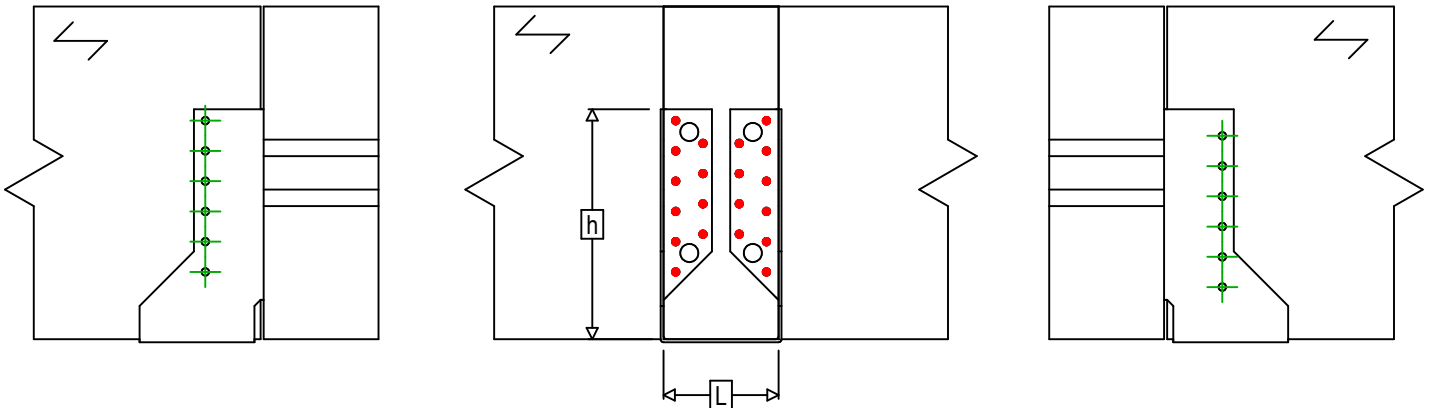

Artikelbezeichnung =	SAIX380		
Verbindungsmittel =	Holz an Holz	Nebenträger an Hauptträger	
Verbindertyp =	Vollausnagelung		

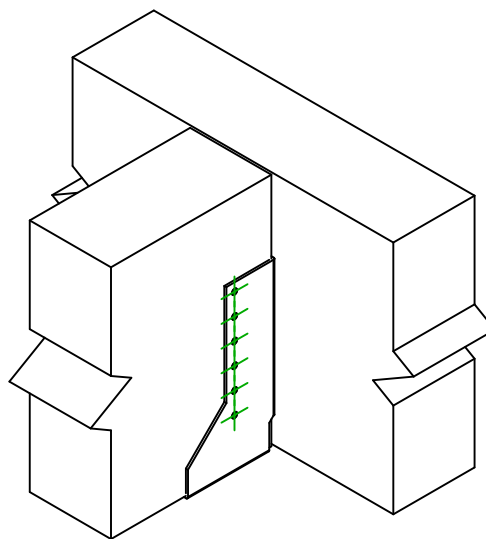

$$h = (380 - L) / 2$$



Verbindungsmittel am Hauptträger	Symbol	Verbindungsmittel	Verbindungsmittel		Anz.	
		CNAS		CNA4.0X35S / CNA4.0X50S		20
		CSAS		CSA5.0X35S / CSA5.0X40S		
-		-	-			
Verbindungsmittel am Nebenträger	Symbol	Verbindungsmittel	L < 64mm	L > 64mm	Anz.	
		CNAS		CNA4.0X35S	CNA4.0X50S	12
		CSAS		CSA5.0X35S	CSA5.0X40S	