

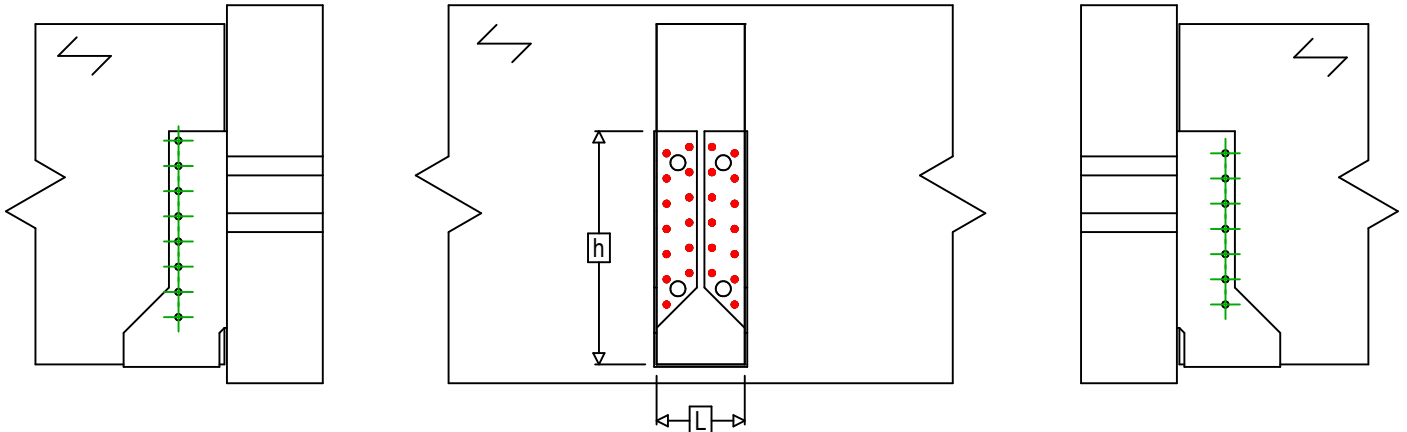

Art. Nr.	=	SAIX440	
Fastgørelsesmidler	=	Træ til træ	Bjælke til bjælke
Type af fastgørelse	=	Fuld udsømning	

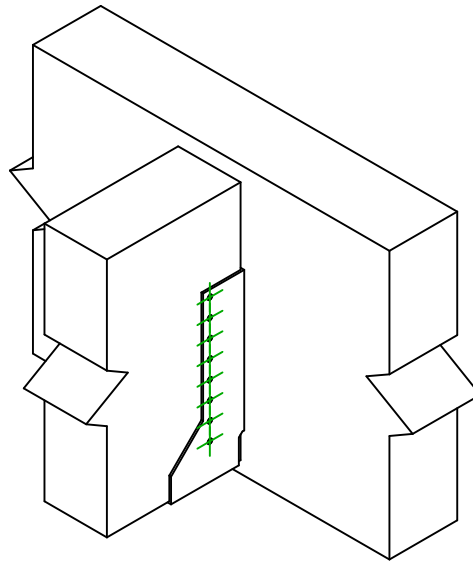

$$h = (440 - L) / 2$$



Fastgørelsesmidler i hovedbjælke	Symbol	Fastgørelsesmidler	Fastgørelsesmidler		Antal	
		CNAS		CNA4.0X35S / CNA4.0X50S		26
		CSAS		CSA5.0X35S / CSA5.0X40S		
-		-	-			
Fastgørelsesmidler i sekundær bjælke	Symbol	Fastgørelsesmidler	L < 64mm	L > 64mm	Antal	
		CNAS		CNA4.0X35S	CNA4.0X50S	15
		CSAS		CSA5.0X35S	CSA5.0X40S	