

**SIMPSON****Strong-Tie**

# Utspikning



REV

0

REV DATE

26/07/24

DWG NAME

C\_SAIX500\_2D0\_NP\_JTB-FN-SE

Art. Nr.

=

SAIX500

Fästelement

=

Trä till trä

Balk till balk

Typ av infästning

=

Fullständig utspikning

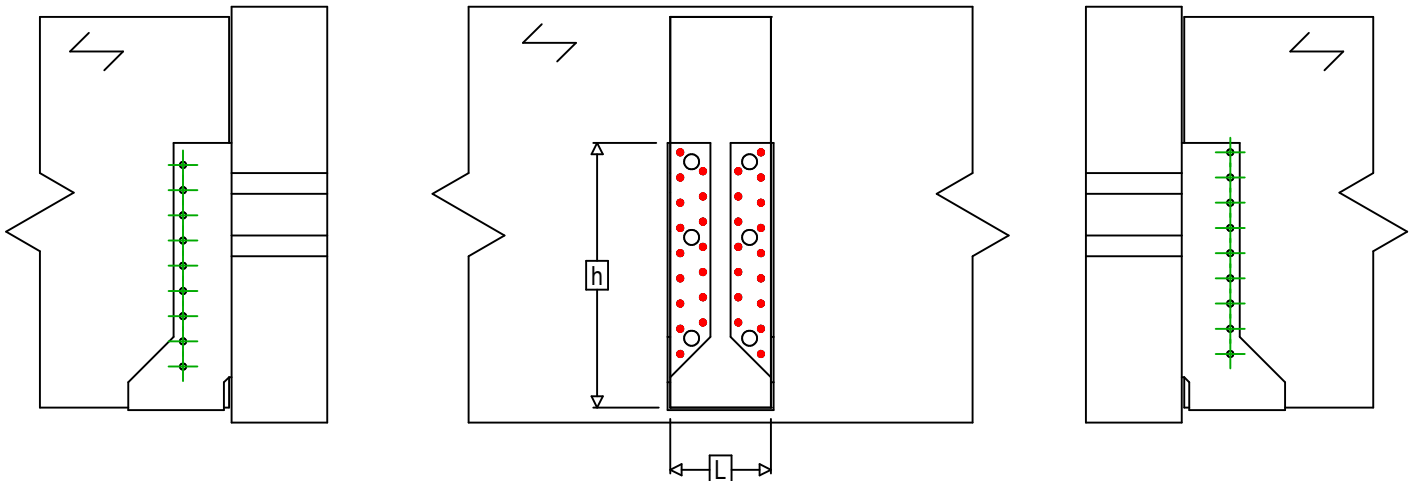

$$h = (500 - L) / 2$$

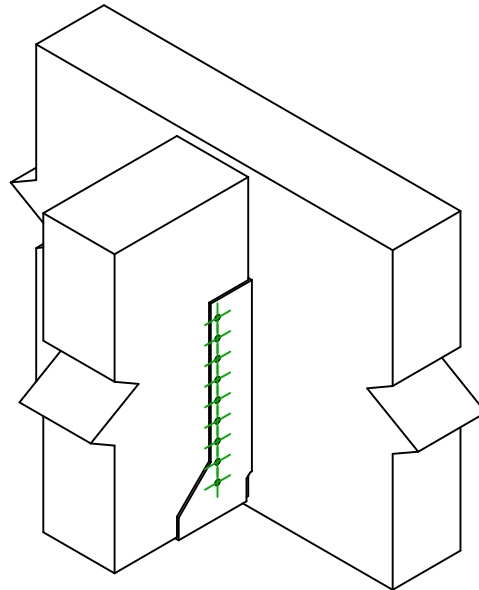

	Symbol	Fästelement	Fästelement		Antal
	Infästning i huvudbalk		CNAS	CNA4.0X35S / CNA4.0X50S	
CSAS			CSA5.0X35S / CSA5.0X40S		
-			-		
Fästelement i sekundärbalk	Symbol	Fästelement	L < 64mm	L > 64mm	Antal
		CNAS	CNA4.0X35S	CNA4.0X50S	18
		CSAS	CSA5.0X35S	CSA5.0X40S	